

USB

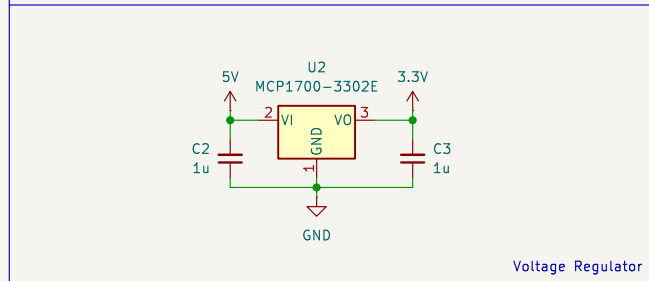

Voltage Regulator

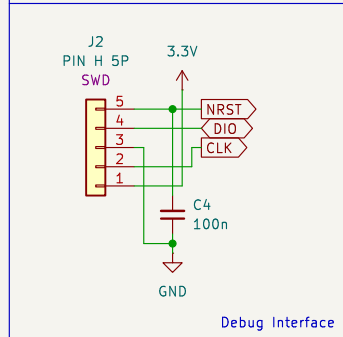

Debug Interface

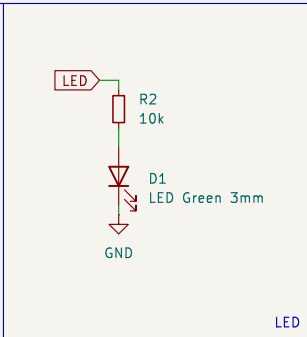

LED

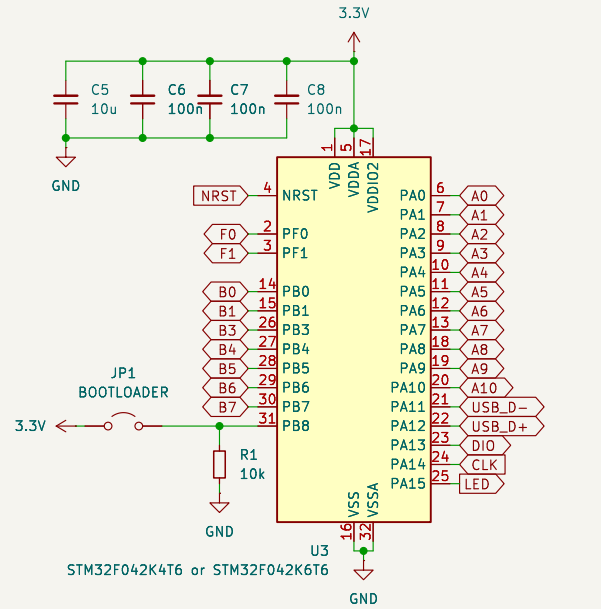

Microcontroller

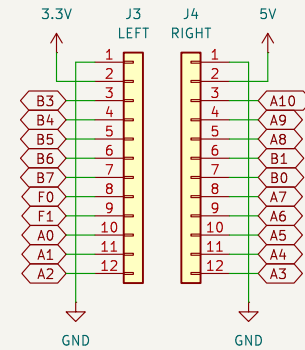

Connectors

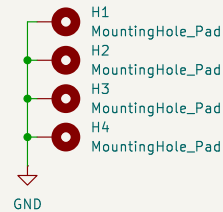

Designed by: Rafael G. Martins

Released under CERN Open Hardware Licence Version 2 – Strongly Reciprocal

Sheet: /

File: stm32f0-usbd-devboard.kicad_sch

Title: stm32f0-usbd-devboard

Size: A4

Date: 2024-12-12

Rev: 20241212

KiCad E.D.A. 9.0.7

Id: 1/1